



Humidifier

**B300**

Electronic



---

2 year guarantee

---

## **Dear Customer,**

*thank you for having chosen the Humidifier B 300. Please read the operating instructions carefully before using your new unit. We recommend that you keep the instructions in a safe place, so you may refer to them when needed.*

## **Principle of Operation**

With this unit, you have purchased a highly effective humidifier and air purifier that offers you all the advantages of today's high-tech appliances. With the proper humidity level, you are not only protecting your health, but also prevent damaging of valuable furnishings, storage goods or prevent product loss when humidity-sensitive production processes are involved. The unit is operated with regular tap water and functions completely free of condensation. The minimal power consumption makes it an environmental friendly device.

The Humidifier B 300 works on the principle of natural evaporation. Thereby the humidifying and purifying process works as described in the following:

The B 300 draws in the air through an air suction opening on the side of the power cable and passes it through an air filter, which filters out the larger dust particles and fine particles. In the inner chamber of the humidifier, the drawn-in air is treated with germicidal UV-C rays and then passed on to the vapor filter. The vapor filter, which continuously glides through the water-bath, produces with its special structure a large evaporation surface. This causes the air to be cleaned one more time. After the humidification and purification, the air is returned back into the room. The Humidifier B300 thereby works based on the principle of circulating air, meaning that air in a closed room is drawn in, cleaned, and moistened time after time until the humidity level set has been reached. The measuring of the room humidity thereby takes place through a humidity sensor with a 2 meter cable. Displaying of the room humidity and the setting of the desired humidity takes place through the operating display. This is where you can also regulate the fan speed.

Humidifier B300 offers a combined function – it cleans, purifies, and humidifies the air. If only the humidifying function is needed, the air purifying function can be reduced by removing the air filters in the suction area, which, however, does lead to a considerable increase of the evaporation performance. The function of the UV-lamp remains in the operating mode.

***We hope that you enjoy your Humidity B 300 unit.***

## **3-module structure**

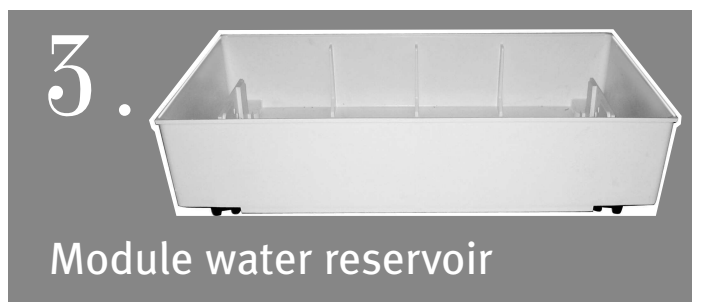
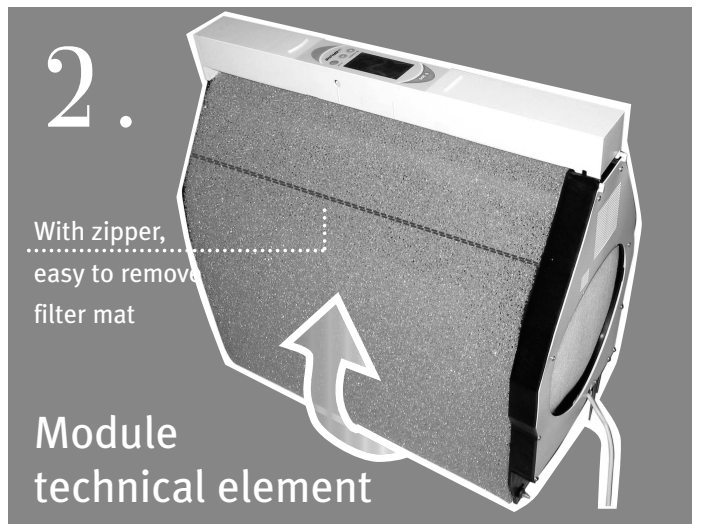
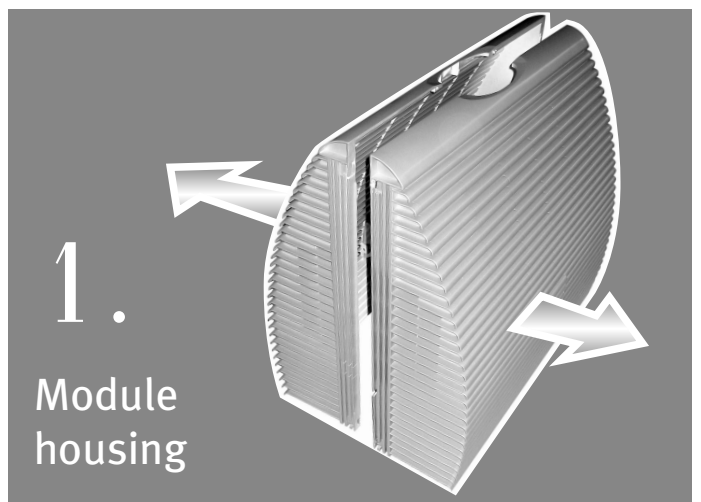

## Safety Instructions /

### Warning

- Children do not recognize the dangers, which can develop while handling electrical appliances. Therefore do never leave children unsupervised when running electrical appliances;
- The unit may be operated only by authorized persons;
- Never operate an appliance with defective power input;
- Make sure that electrical parts do not come into contact with water;
- The appliance is not exposed to influence of the weather (rain, snow, frost); also
- Do not operate the unit with wet hands;
- The unit is set up stable and horizontally onto the ground;
- When absent for a longer time, always pull the power supply plug or ensure that the power supply is disconnected;
- Before cleaning, always first pull the power supply plug;
- Never pull the unit or the power cable at the power inlet, when pulling the power supply plug out of the socket;
- Never move the unit in a filled condition. Water can exit causing damages to the unit or furnishings;
- Service work, for which tools have to be used, may only be performed by the authorized personnel.

### Setup/Location

- Open the packaging and remove all packaging parts from the humidifier.
- Setup the unit onto an even, horizontal surface.
- For an optimal function, the unit may be set up near a heat resource. However, the temperature in that area should not exceed 70° C.
- Check the unit for any possible transportation damages.
- Check whether the delivery is complete, and that all parts belonging to the unit are fitted properly.

### Operating your unit

Before operating your unit, you should ensure that all parts are installed appropriately and that the water reservoir is filled. Please proceed as follows:

## Power Supply

Check whether local mains voltage is the same as the one on the identification label. The identification label is located above the power/net inlet cable and below the fan motor. To locate the label, you first have to remove the outer case of the unit.

## Operating the Humidifier B 300

The operating display of the B 300 informs you about the current condition of the unit. You can read the room humidity, the set fan level, and the water level. By using the switches + /- and AIR, you can input the settings for your unit.



The indicator display and setting of the relative humidity takes place in 5% increments. Therefore, the values may deviate when using other control devices. At 3 and 8, the display jumps over to the next higher value (e.g. actual humidity = 43% corresponds to =45%)

The user can, to a minor degree (+/- 5%), calibrate the display accuracy. Read more about this in the Paragraph "Adjusting the humidity Indicator"

## Switching of On/Off and setting of the fan level – AIR Switch

---

The B 300 is switched on or off by pressing the AIR-button twice. By repeatedly depressing the switch, the different fan modes can be changed

**Standby:** The humidifier is switched off and without function. Attention: The unit still receives power.

**-LOW:** The fan runs on the lowest output level. The noise level is optimized

**-HIGH:** The fan runs on the highest output level, for a maximum output of humidity and air purification.

**AUTO:** The fan runs automatically according to the performance requirements, which is controlled by the actual room humidity.

If the AIR-key is pressed, the symbol on the indicator display starts to blink and, after pressing the switch again, jumps to the next operating mode. By depressing the AIR-switch again, the status can be changed to the next mode. In this condition, the symbol blinks until the desired status is reached and for 2 seconds, another setting was not selected. After that, the symbol no longer blinks, and the selected operation mode is performed. Please note that when the AIR-key is depressed the first time, only the setting mode is started and the operating mode does not change. Only by depressing the AIR-switch again, the operating modus is changed.

## Changing of the – HUMIDITY-Switch

---

If the unit is turned on, with the humidity keys +/- the desired relative humidity can be changed upward or downward. During the pressing of the keys "+" or "-" the indicator jumps from the actual room humidity to the desired value according to the setting. By repeatedly pressing the + or – switch, the value is accordingly changed. If the desired value is adjusted, the indicator display jumps back after few seconds to the actual room humidity and the new desired value was recorded and stored.

## Function "Switch/key lock"

---

To lock the control keys for children or strangers, to disable the use of the operating panel, is integrated. It is switched on and/or deactivated by simultaneous pressing of the 3 keys (AIR KEY and the two HUMIDITY keys) for 3 seconds. If the key disabling device is activated and a key is pressed, all control elements in the display blink. The key lock must be deactivated. Only after pressing the 3 keys again, the settings can be changed.

## Safety of the unit

---

The unit is equipped with two micro switches, which, when opening the casing of the unit, switches via the control all components of the B 300 off. The disconnection via the micro switch is signaled via a flashing STAND-BY indicator. Only if the casing is completely closed, the Standby indicator turns off and the air humidifier takes up again operations.

## Filling the tank

---

To fill the water reservoir of the B 300, switch off the unit as described above. The indicator in the display helps you to determine the correct level. Now open the lateral filler flap on the right or left side (see fig. 1). Grab the flap at the grip above and pull it up to the stop outward. Now you fill up the tank to the water level as indicated on the display, using a suitable container (e.g. watering can or similar).

It is important that you do not spill water around the unit or overflow the humidifier. The exiting water can damage your furnishings or your unit.

## Accessory Water Supply (AWS)

The connection to the local water line network must take place via a specialist, e.g. a certified plumber. (Please comply with the regulations of the local water supply company). A return flow stop may be recommendable for the connection between unit and water pipeline, we recommend our 1,5m long safety pressure hose (Art. No. 1754). The automatic water supply takes place controlled by a solenoid valve (water inlet). The unit comes standardized with the water supply set automatically on a max. of 12 liters. This means that after the fill level has reached 12 liters, the water supply shuts off. The controlling of the water supply takes place via the electrode bars of the water level indicator. For a perfect functioning of the automatic water supply, the electrode bars must be cleaned regularly with a sponge to free them from lime and dirt deposits.

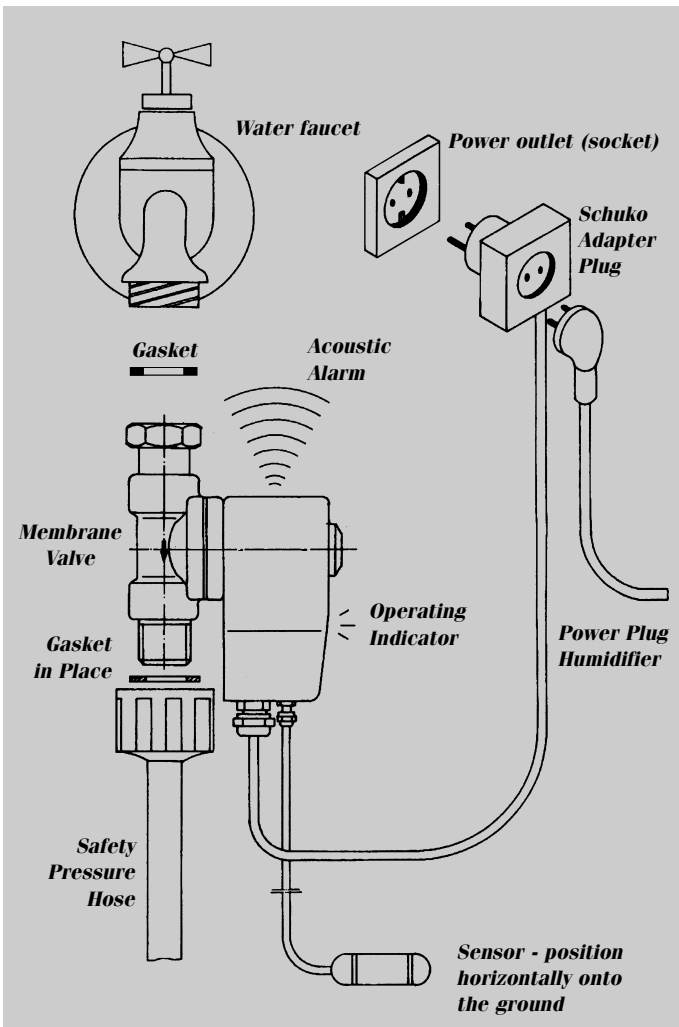

**Accessories: Water guard**

## Repair and Maintenance

To guarantee an optimal functioning and a long lifetime of your B 300 unit, repair and maintenance are inevitable. Depending on the conditions in the room environment, (air and water quality), the need for repair and maintenance can differ (see the table maintenance intervals). The required works are described systematically in the following chapter.

***For all works on the unit, always unplug the humidifier or otherwise make sure that power to the unit is off!***

### Opening the Casing

To perform various maintenance works, first the casing must be opened. Although the unit does provide for an automatic switch-off, when the casing is opened, to insure safety, the power should be turned off and/or the power supply should be pulled.

For the opening of the casing, remove the lock clips at the upper and lower side of the humidifier. Now the two halves of the casing can be pulled open in both arrow directions (see picture below). Handle the casing parts with care so that they are not damaged.



Now you can also remove the technical module. To remove the module, lift it completely upwards. For reinserting the technical module, slide it into the unit along the on the bottom of the water reservoir located gliding mechanism. Attention: check the tension of the blue vapor filter; it can increase during the procedure. The tension can be increased prior to the maintenance procedure by means of the tension pulley delivered with the unit.

The reassembling takes place in reverse order. First slide one half of the casing on the water reservoir up to the center of the unit. Afterwards the second half of the casing is assembled likewise onto the tub and pushed toward the center.

***Disconnect the mains plug before opening the equipment!***

Now you can snap the lock clips. Make sure that all lock clips are locked securely.

Attention: When mounting the casing half, it is important that the orientation is followed correctly. See the recess for the power cable.

## Changing the Filters

### Air cleaning filter

To change the air-cleaning filter, the casing has to be opened first (for instructions see the chapter about Opening the Casing). Now the air-cleaning filter can be removed by hand from its position. It is important that no residue remain. Once the old filter is completely removed, the new filter (Art. No. 6361) can be inserted. Position the new filter into the same place as the old one. It is important that filter does not interfere with the rotor blades of the fan. In addition, the filter edges should not extend outward.

### Vapor Filter

For a comfortable changing of the filter, we recommend to keep the water level as low as possible.

First, open the casing (for instructions see the chapter about Opening the Casing). The old vapor filter can now be removed in that you either open or cut the zipper. Remove the filter completely. Check the water reservoir for any residue, and if present remove it. Dispose of the old filter fleece into the residual waste.

Now remove the tension pulley (see illustration). You can now start with the inserting of the new filter (Art. No. 6360) as shown on the picture. Close the zipper and check the tension. If it is sufficient, you can close the casing as described in the previous chapter. If the tension is not sufficient, insert the tension pulley and repeat the process as described above.

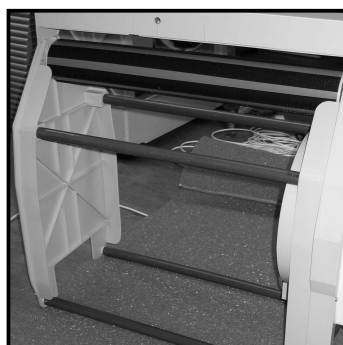
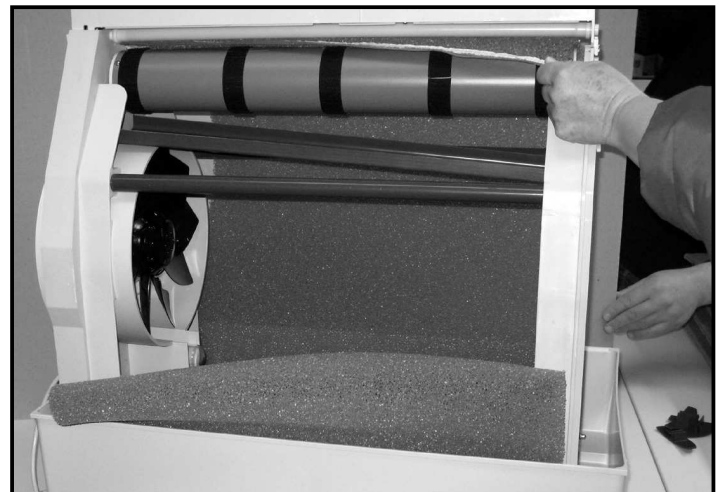

## Changing of the UVC Lamp

---

The change of the UV lamp should take place via authorized technical personnel. For all work on the unit pull the power supply plugs or ensure that the power is disconnected! For changing the UVC lamp, the casing is opened as described before and the technical unit is taken out of the water tank. Afterwards the cover of the technical unit is unscrewed and the screws at the bulb socket of the UV lamp are removed. Now the UV lamp can be pulled out to the rear. Pull the defective lamp from its socket and insert the new UVC lamp (Art. No.: 6210). Afterwards you push the lamp back again into the UVC protecting glass (Art. No. 6212), Fit the socket with the existing screws and close the cover of the technical unit. Please also examine the surrounding parts during the exchange of the UVC lamp such as the UV protecting glass and the seal (Art. No. 6213) of the UVC lamp. If you should determine damages, the unit may be operated again only after having exchanged the defective part.

Please dispose the defective UVC lamp in the same manner as fluorescent tubes according to the specific local regulations of your domicile.

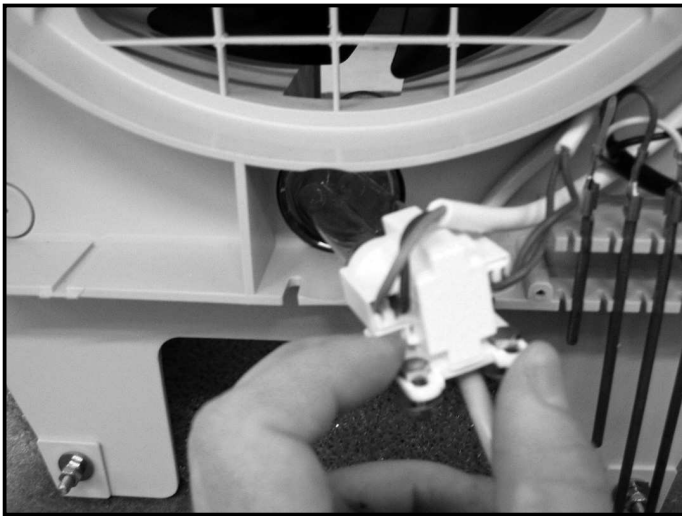

## Cleaning of your Humidifier B 300

---

Every 3-4 months the unit should be cleaned from lime arrears and contamination (dependent on the site conditions: Water hardness dusty condition air quality). For this procedure, the casing is opened as in picture "1." (See also chapter on Opening the Casing). The cleaning can be accomplished with commercial cleaning agents. Do not use benzene or other solvents that can damage plastics! To remove lime residues please use the lime remover of the brand Brune (Art. No. 9016) or a commercial lime remover. All cleaning agent residues must be completely removed (rinse well with clear water), since otherwise a foaming of the cleaning agents can damage the unit.

If the unit is not operated for a longer time, the residual water is to be emptied and the tension of the vapor filter is to be decreased (see the chapter on Changing Vapor Filter). Additionally, the unit should be cleaned.

A basic cleaning should take place annually (possibly by our maintenance service).

## Adjusting the humidity indicator

---

An authorized specialist should perform the adjustment. The Humidifier B 300 offers the possibility to adjust the indication of the relative humidity within a range of  $\pm 5\%$  of the actual value, and thereby to adapt the display to other devices or measures. Please note that there is a microclimate in each zone of a room area and therefore the different value displayed from one unit to another unit or appliance, is possible and correct. For adjustment/calibration, proceed as follows:

- opening the casing as described in the section "opening the casing"
- with a small screwdriver, carefully turn the adjustment pot (potentiometer). It is located underneath the circuit board and is accessible by a hole in the casing at the operating panel. You should make the adjustment in several steps, i.e. make only a small turn at the potentiometer, and check the result at the display. If the desired result should not be reached yet, turn again carefully at the potentiometer.
- Close casing after adjustment.



## Maintenance intervals

The following listed maintenance works should be performed in the indicated time intervals. For all maintenance or repair, always pull the power supply plug or ensure that the power supply is disconnected!

## Technical Data

Power supply:	230V AC
Performance:	max. 58 W
Fuse:	2 A
Safety check:	CE
Capacity of water reservoir:	approx. 25 L
Air performance max. (free blowing):	600 m <sup>3</sup> /h
Vapor performance max.	1.4 L/h
Length of power cord:	2.5 m
Weight (w/out water):	21 kg
Measurement (W x H x D):	74 x 71 x 41 cm

Maintenance intervals	Work to be performed
daily	<ul style="list-style-type: none"> <li>● Water level: check via the display. The unit shuts off automatically, when empty (not applicable for units with automatic water supply)</li> <li>● Humidity level: check via the digital indicator (display).</li> </ul>
3-5 weeks	<ul style="list-style-type: none"> <li>● Casing: check for dirt (dust in the air take-in area, etc.), if necessary remove</li> <li>● Air filter, check and if necessary change (only use original parts of the Brune brand). The filter should be changed no later than 20 weeks after initial operation.</li> <li>● Vapor filter, check and if necessary change, (only use original parts of the Brune brand). The filter should be changed no later than 20 weeks after initial operation.</li> <li>● Cleaning of the water reservoir (see chapter on Opening Casing). Important: when using Water-Fresh avoid over dosing.</li> <li>● Electrode bars: check for dirt and lime residue (if necessary clean with a sponge and the appropriate cleaning agents)</li> <li>● Vapor filter fleece: check for sufficient tension (see chapter Changing Filters)</li> </ul>
12 months	<ul style="list-style-type: none"> <li>● perform complete cleaning of the unit</li> <li>● change air suction filter</li> <li>● change vapor filter</li> <li>● clean copper electrodes</li> <li>● check UVC-Lamp</li> <li>● clean glass of the UVC</li> <li>● For changing the UVC lamp, see chapter on Changing UVC lamp (normal operation time approx. 5000 hours)</li> </ul>

The indicated time intervals apply to normal water quality and normal dust accumulation and may vary accordingly.



## Error Correction

Error	Cause	Solution
Not functioning at all (no standby indicator)	Unit not connected to power supply	Check power input
	Fine-fuse of the circuit board blown	Replace fine-fuse of the circuit board
No Function (Standby –Symbol blinks)	Micro switch deactivated unit	Check casing that it is completely locked
Water level indicator missing	Water level too low	refill water
	Copper electrodes dirty	Clean copper electrodes
Unit runs, but vapor filter does not move	Tension too low	Increase tension, see "Changing of Filters"
		If still too low, replace vapor filter.
		Possibly exchange driving roller.
Unit leaks water	Vapor filter rubs against casing	Increase tension see "Changing of Filters" If still too low, replace
	Check water reservoir for damages	Replace water reservoir
Automatic water supply has stopped	Safety pressure hose defect – water supply is stopped automatically	Replace hose
Automatic water supply runs uninterrupted	Water inlet valve (solenoid valve) does not close	-Dirt residue in the water feed tube
		-check Electrodes for pollutants
		-Replace solenoid valve
Water guard gives acoustic signal	Water leaks	Check for the cause. Cut off supply for water guard from the net for some seconds

# Exploded view und list of parts

# B 300

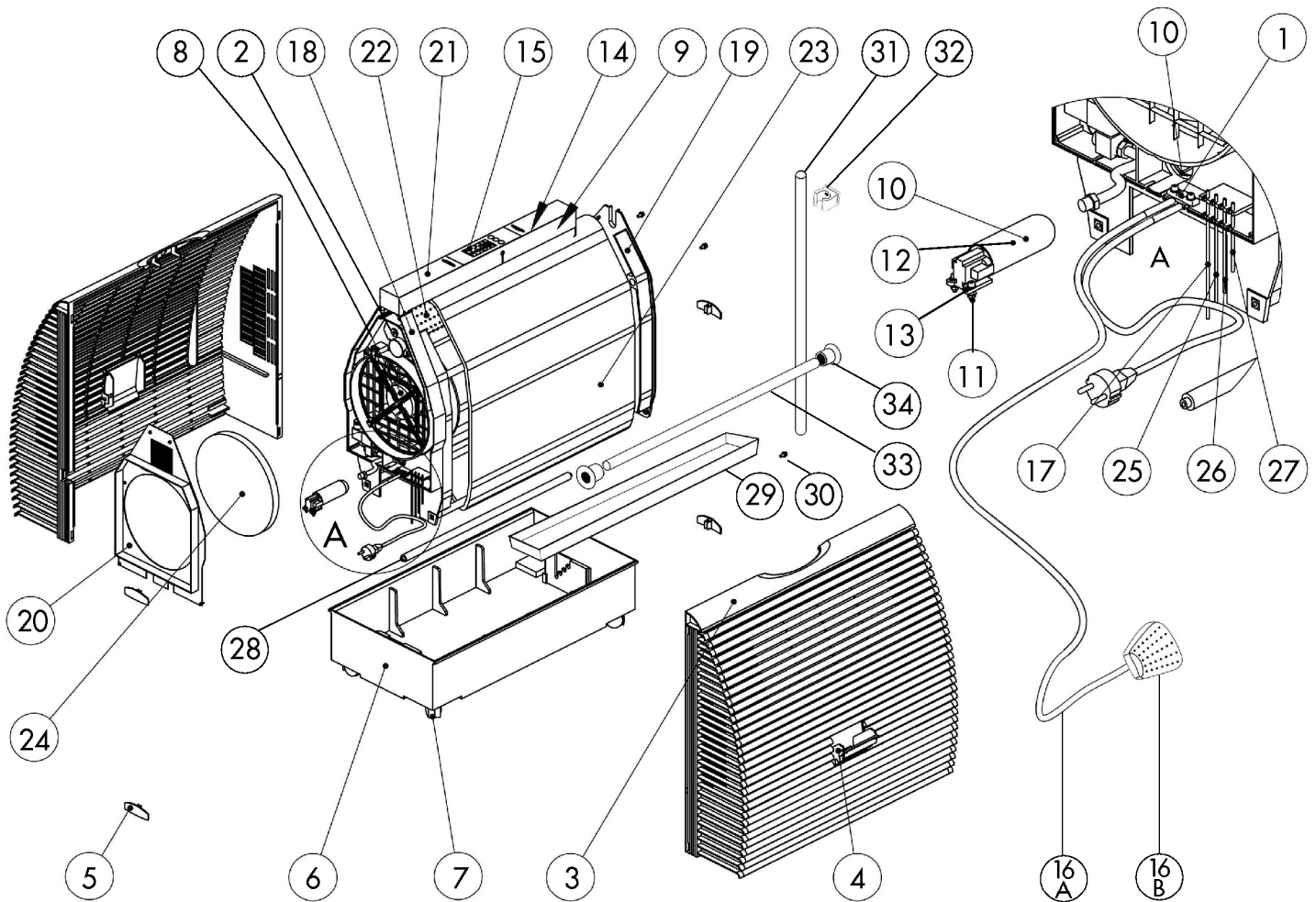

POS.-NR.	ART.-NR.	DESCRIPTION	POS.-NR.	ART.-NR.	DESCRIPTION
1	1351	Strain relief cabel	21	6321	Casing operating part B 300
2	2589	Gear motor B 300	22	6325	Drive cylnder B 300
3	6101	Casing exterior-1	23	6360	Vaporfilter blue
4	6111	Latch water inlet B 300	24	6361	Airfilter B 300
5	6112	Latch clips	25	6227.1	Electrode 145 mm
6	6201	Water reservoir B 300	26	6227.2	Electrode 90 mm
7	6202	Guide pully B 300	27	6227.3	Electrode 48 mm
8	6205	Fan axial, diameter: 250 mm	28	6328	tension pully
9	6206	Condensator for fan motor Art.-Nr. 6205	29	6329	drip tray underneath the filter
10	6210	UV-Lamp 5 Watt	30	6329.1	screw for fastening of the drip tray
11	6211	Lamp socket UV-Lamp	31	6329.2	drain pipe for the drip tray
12	6212	Protective glass UV-Lamp - round	32	6329.3	fastening clamp for drain pipe
13	6213	Gasket for UV-Lamp diameter: 36	33	6330	Filter roll above the drive roll
14	6217	Balast for UV-Lamp	34	6312	left and right mount for the drive roll
15	6222	Keypad foil			
16	6225	Humidity sensor			
16/A	6225.1	cable for humidity sensor			
16/B	6225.2	sensor box			
17	6227	Electrode 152 mm			
18	6301	Side panel B 300 technique- motor			
19	6302	Side panel B 300 without technique			
20	6311	Cover for side panel B 300 technique			

## Water-Fresh

Water-Fresh is best suitable for all humidifiers, which work according to the evaporator principle. It prevents alga formation and decreases lime deposits in the unit. Water-fresh is not transferred to the room air, and, if appropriately applied, does not harm your health. It is available as 1-liter bottle (order number 9020) or 5-liter canister (order number 9022) with a measuring cup.

With the use of water-freshly please only use exactly the amount as indicated in the instructions (25 ml to 10 liters of water). An overdosing can cause foaming and thus damage the electronic elements of the unit. The residual water container with up-graded concentrations of Water-Fresh should also be emptied regularly. Use Biocides safely. Before using, please read the production information carefully.



## Optima

### **Optima Lime Scale Solvent**

*The highly concentrated Lime Scale Solvent is especially suitable for air humidifiers and for all sanitary areas such as WC, showers, swimming pools, bath-rooms, etc. It is based on phosphoric acid and is odour free without acrid fumes.*

*Application: 100 - 1000 grams of Optima to 10 litres of water. For heavy staining use pure and immediately rinse abundantly with water. Read safety instructions before use.*



## Legal Notice

These operating instructions contain the necessary information for the intended use, the correct operation, and adequate maintenance of the equipment.

The knowledge of and the complying with the instructions contained in these operating instructions are a condition for the safe use as well as for the safety during operation and maintenance.

These operating instructions cannot take into consideration of each conceivable use. The unit and the accessories are designed for private and commercial use.

In addition, we point out that the contents of these operating instructions are not part of an earlier or existing agreement, promise, or a legal relation or amendment of the original. All obligations of Brune Luftbefeuchtung Proklima GmbH are as specified in the respective sales contract, which also contains the complete and solely valid warranty conditions. These contractual warranties are neither extended nor limited by the statements in these operating instructions. The operating instructions contain information, which is protected by copyright. Photo copying or translating into another language is not permitted without previous written permission by Brune Luftbefeuchtung Proklima GmbH.

These operating instructions have been translated for your convenience. In case of conflict, the original operating instructions in the German language shall be applicable.



*Luftbefeuchtung Proklima GmbH*

Luftbefeuchtung Proklima GmbH · Schwarzacher Str. 13 · D-74858 Aglasterhausen

Telefon ++49 (0) 62 62 - 54 54 · Telefax ++49 (0) 62 62 - 32 55

---

www.brune.info · mail@brune.info